









 Ø6,3x50 mm A1 x 28	 Ø12 mm A2 x 28	 4 mm A3 x 1	 Ø10 mm A4 x 24	 Ø15x12 mm B1 x 26
 Ø5x44 mm B2 x 26	 Ø20 mm B3 x 26	 Ø4x16 mm D1 x 96	 Ø3x16 mm D2 x 24	 Ø4x25 mm D3 x 16
 Ø1,6x25 mm F x 52	 Ø8x36 mm G x 36	 Ø5x16 mm L x 2	 300 mm K x 4	
 N x 6	 S x 6	 T x 4		

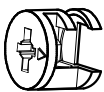
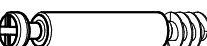

Box 1

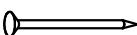
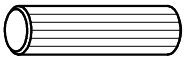
777x628x16 mm

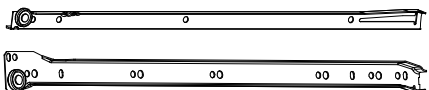

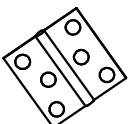
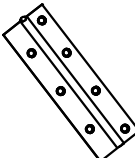
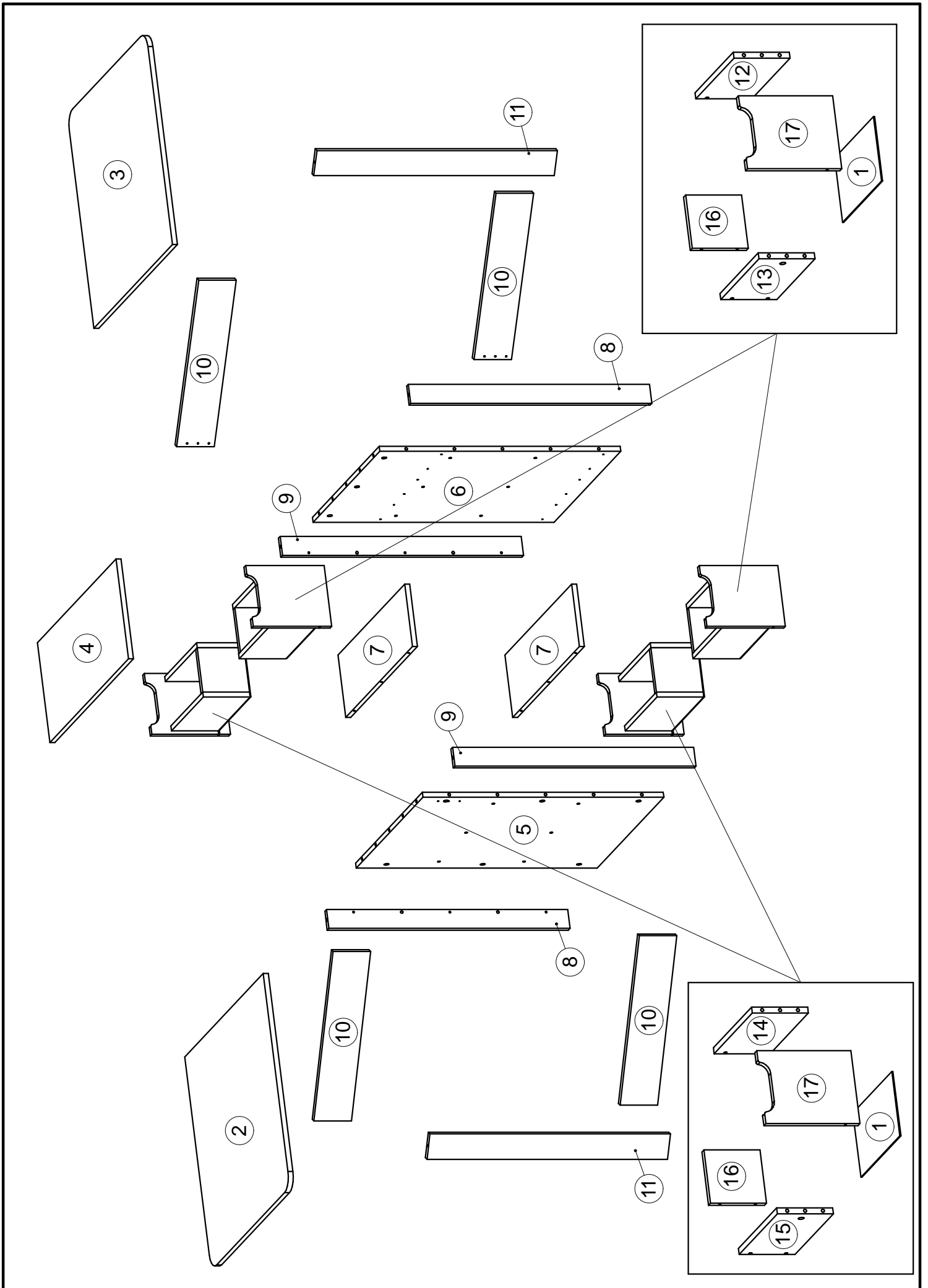
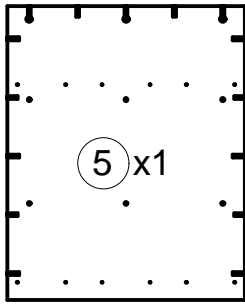
777x628x16 mm

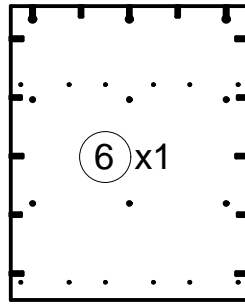

777x60x16 mm

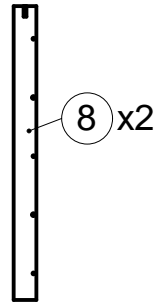

777x60x16 mm

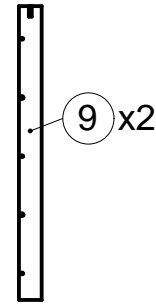

775x80x16 mm

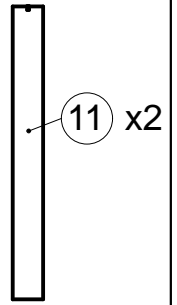

300x150x16 mm

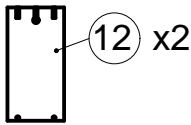

300x150x16 mm

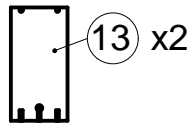

300x150x16 mm

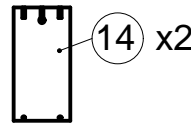

300x150x16 mm

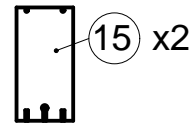

150x143x16 mm



252x195x16 mm

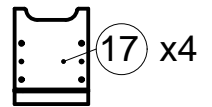

Fittings & Tools

Box 2

201x628x16 mm

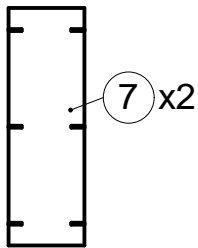

540x120x16 mm

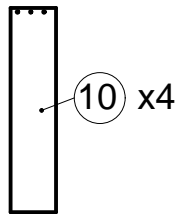

688x740x16 mm

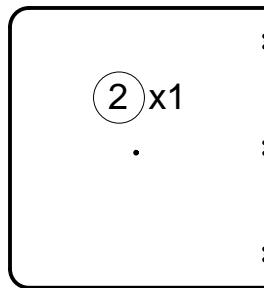

688x740x16 mm

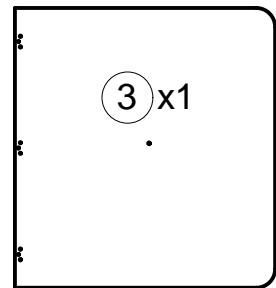

321x740x16 mm

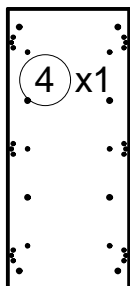

306x173x3 mm

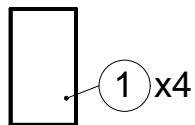

1

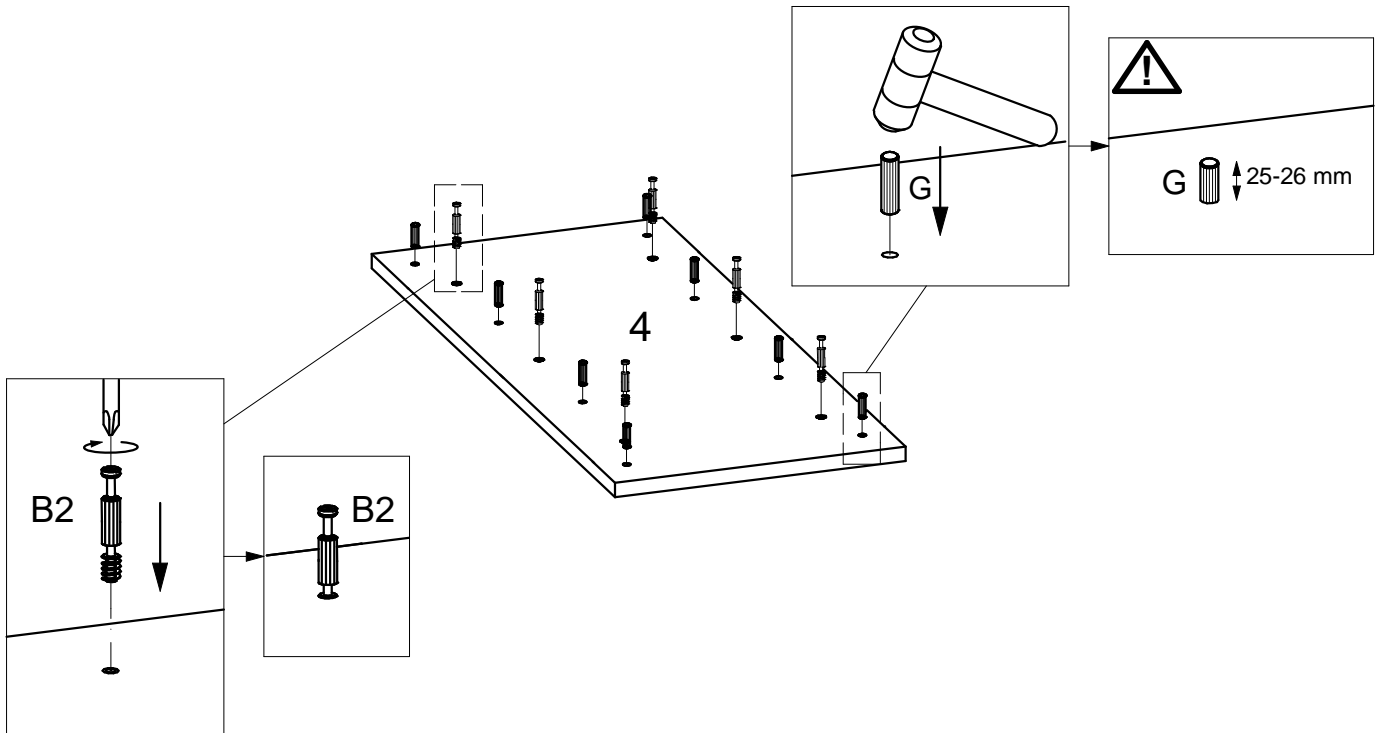
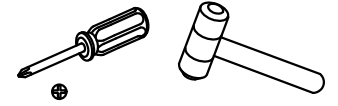
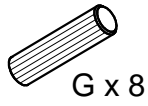
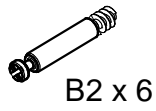

2

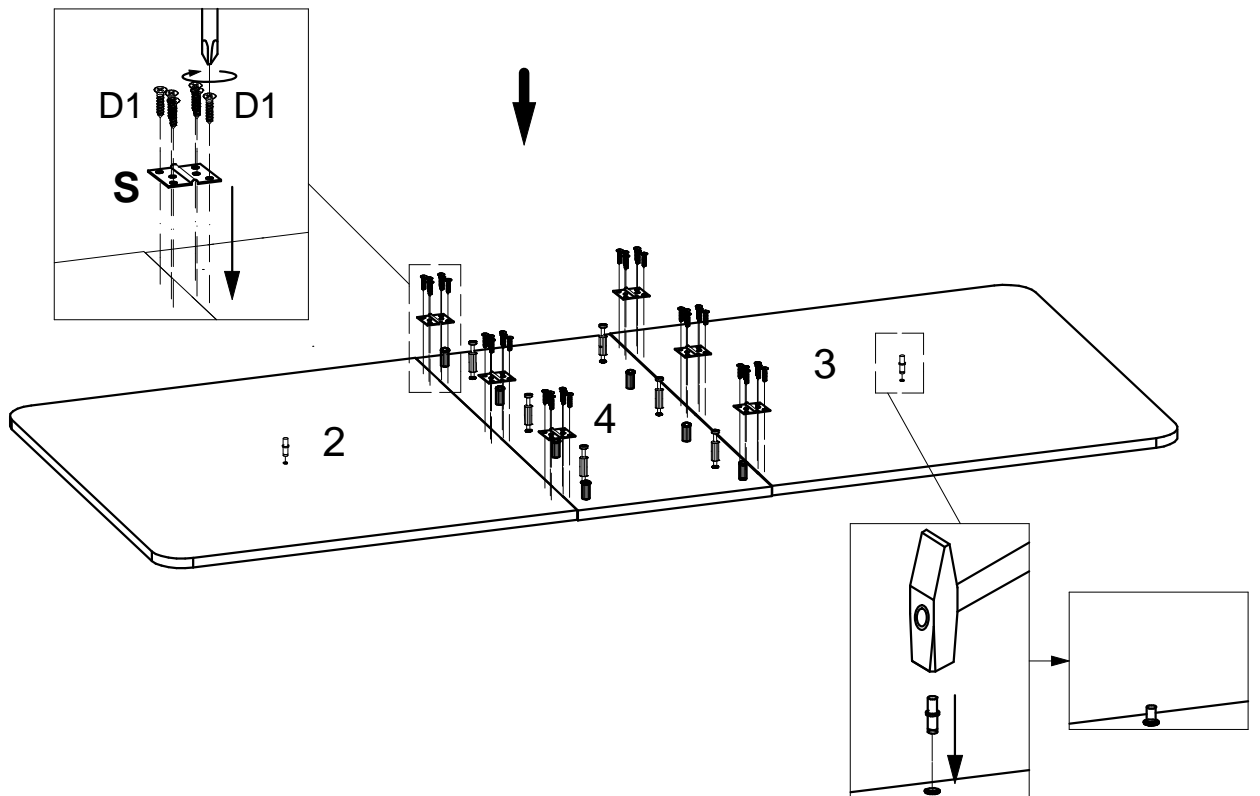
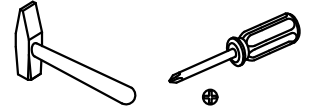
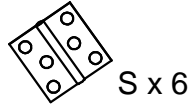
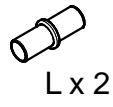
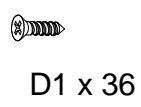

3



B1 x 3



D2 x 12



K1 x 4

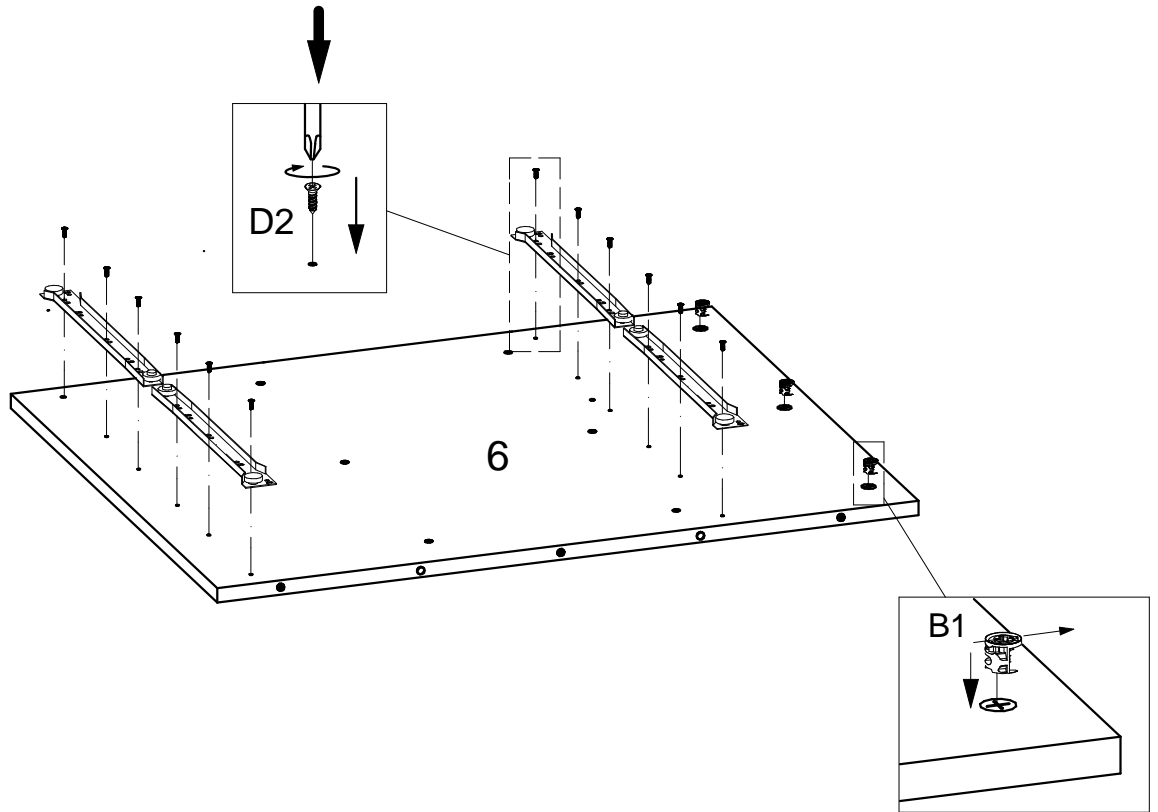
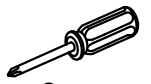

4



B1 x 6



D1 x 6



T x 2

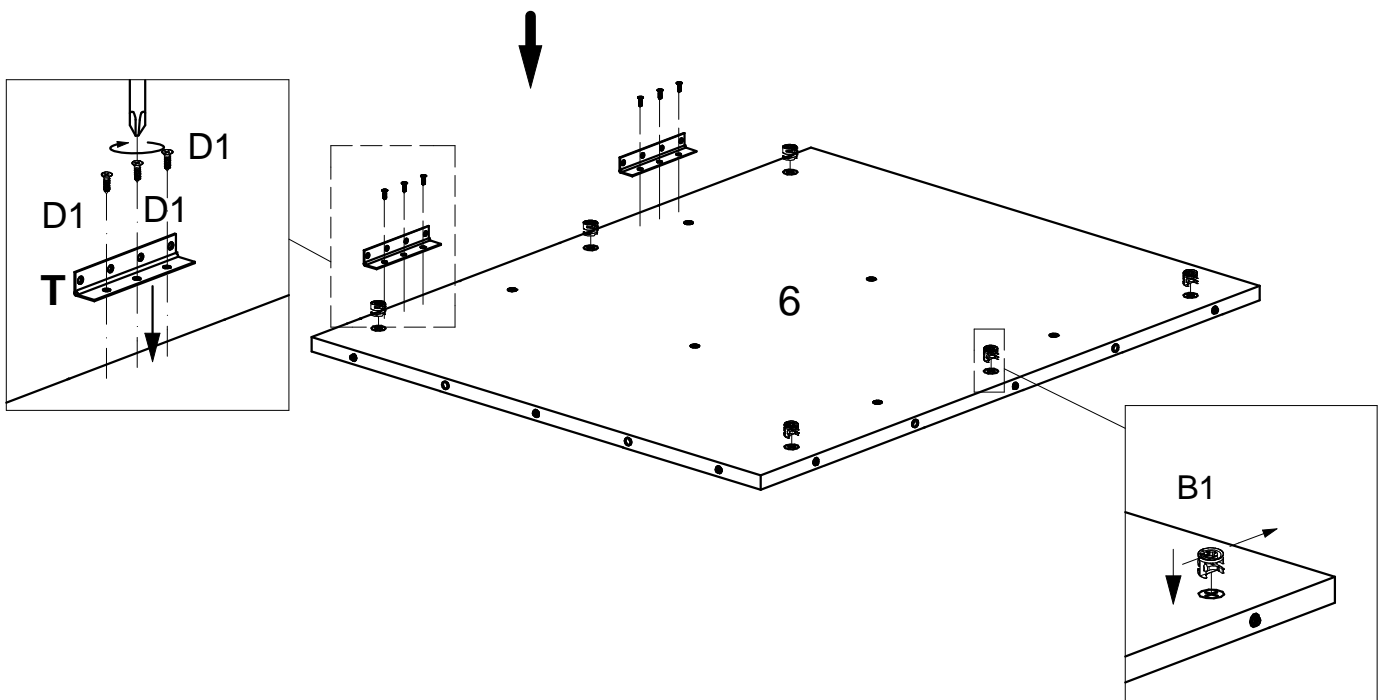
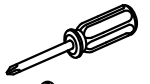

5



B1 x 3



D2 x 12



K2 x 4

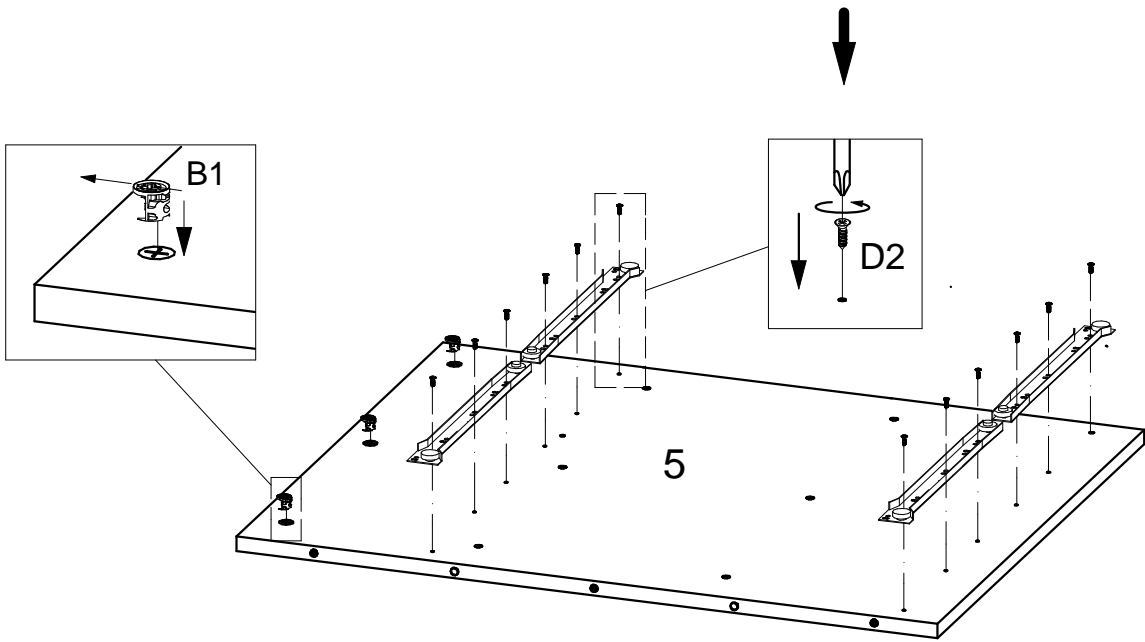
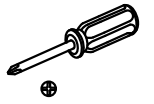

6



B1 x 6



D1 x 6



T x 2

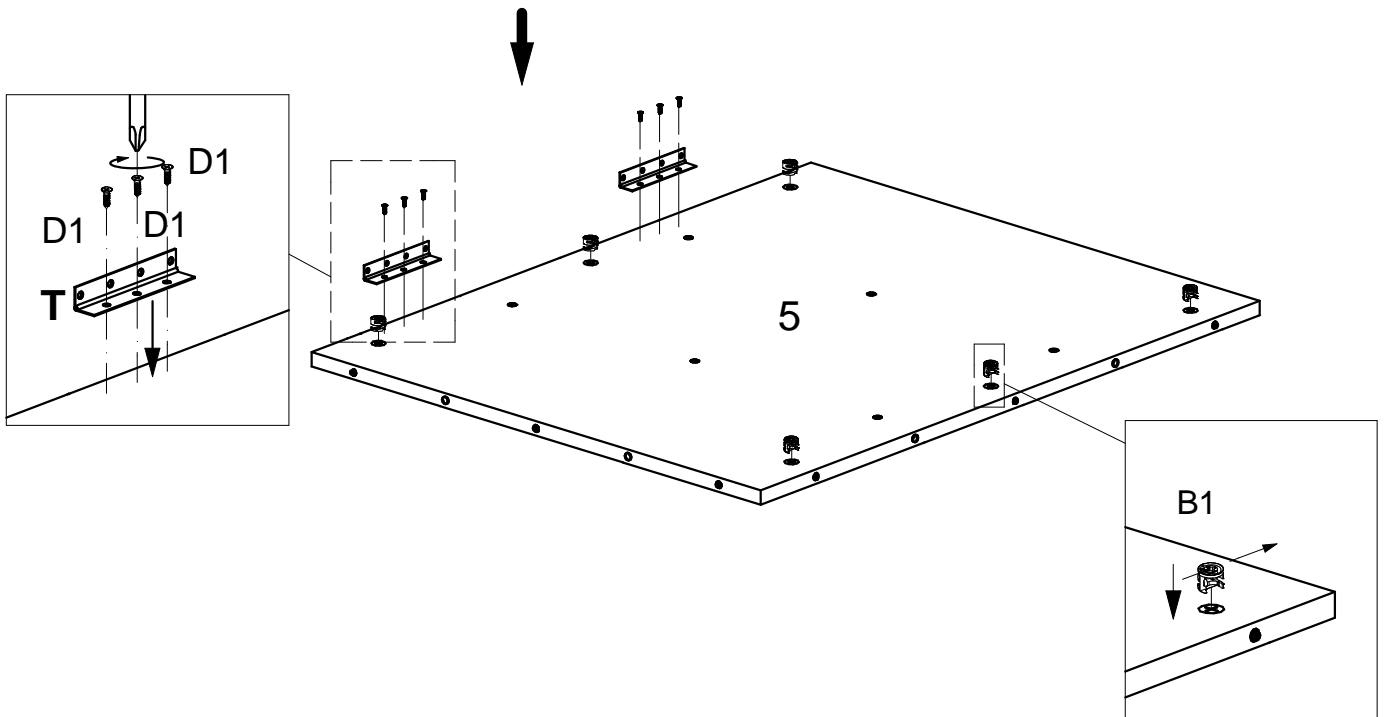
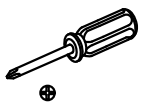

7

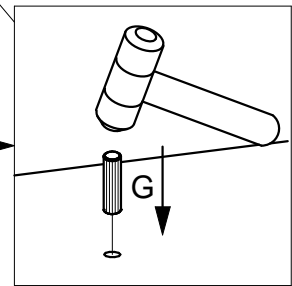
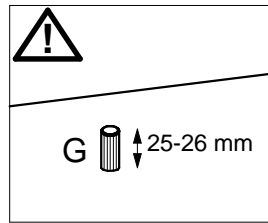
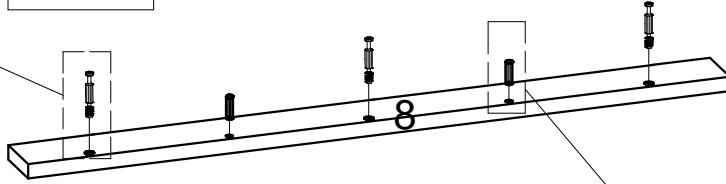
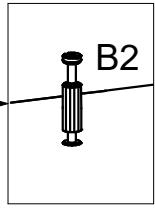
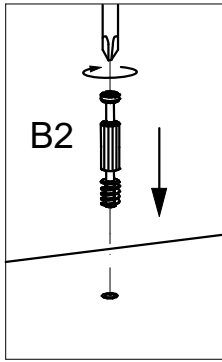
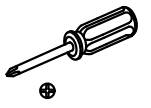
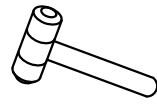
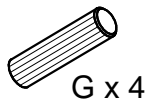
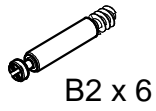

x 2

8

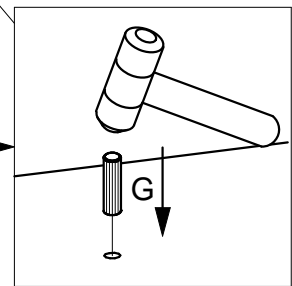
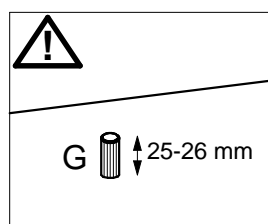
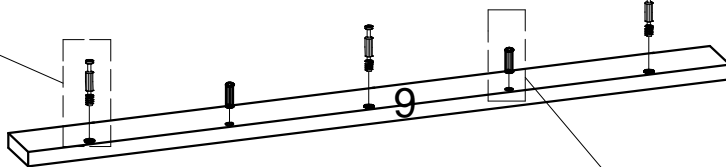
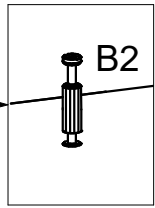
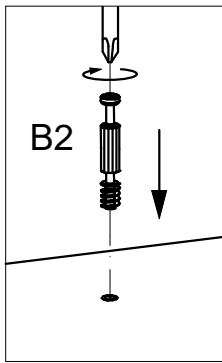
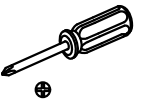
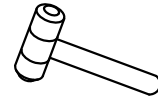
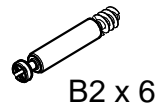

x 2

9

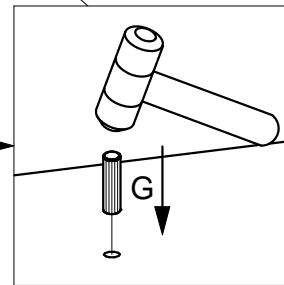
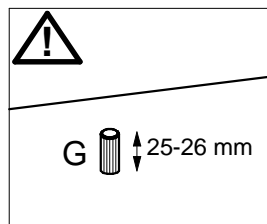
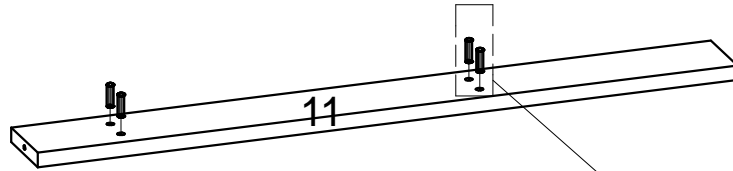
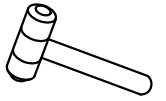
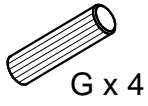

x 2

10

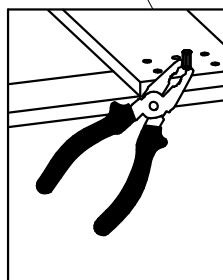
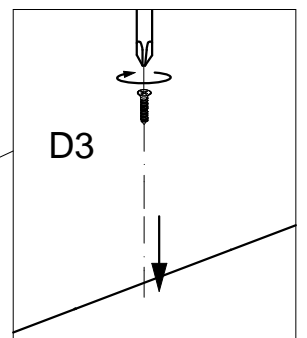
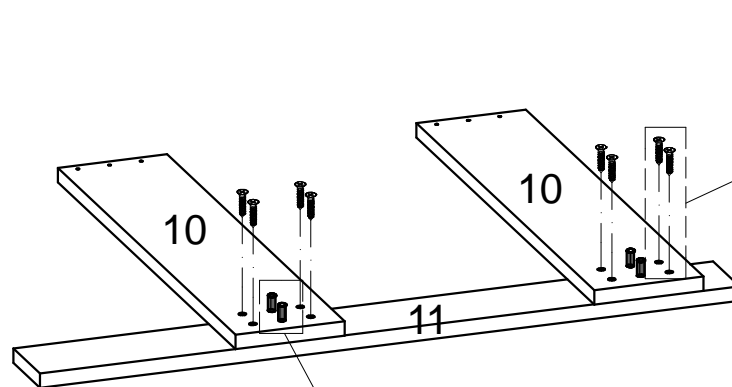
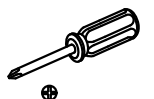
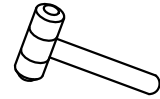
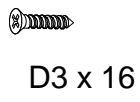

x 2

11

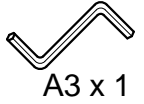

A1 x 12

A2 x 12

A3 x 1

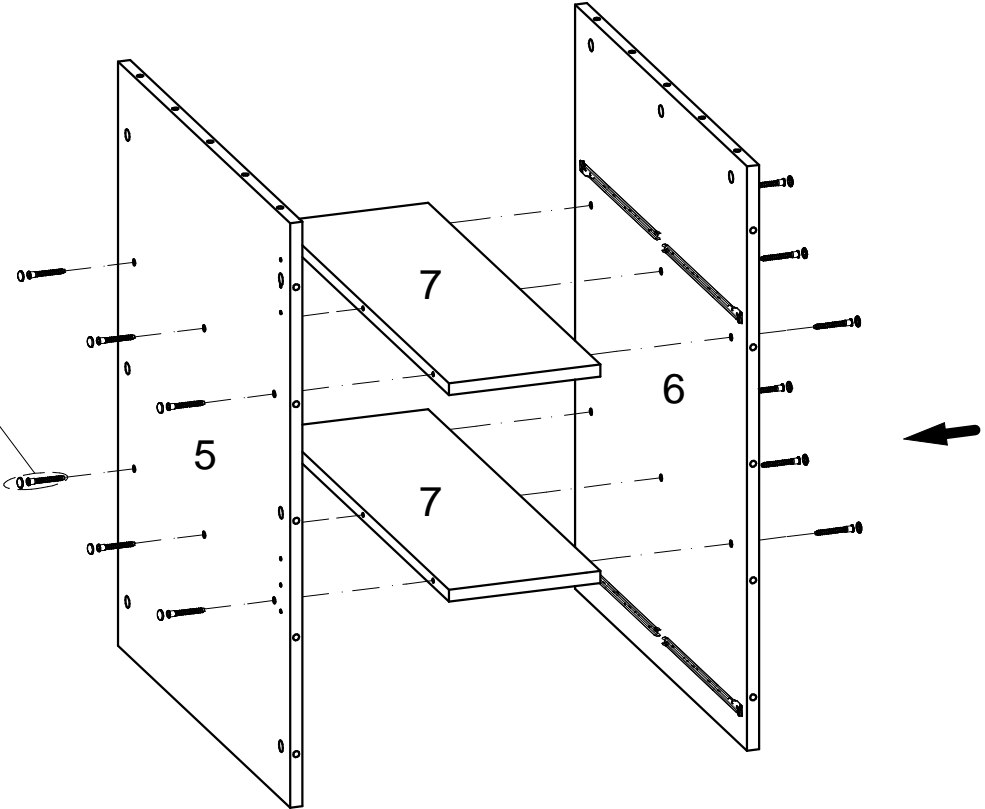
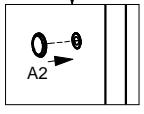
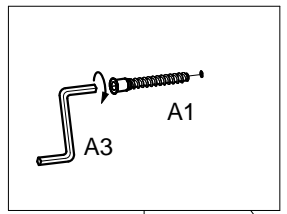

12



B3 x 12

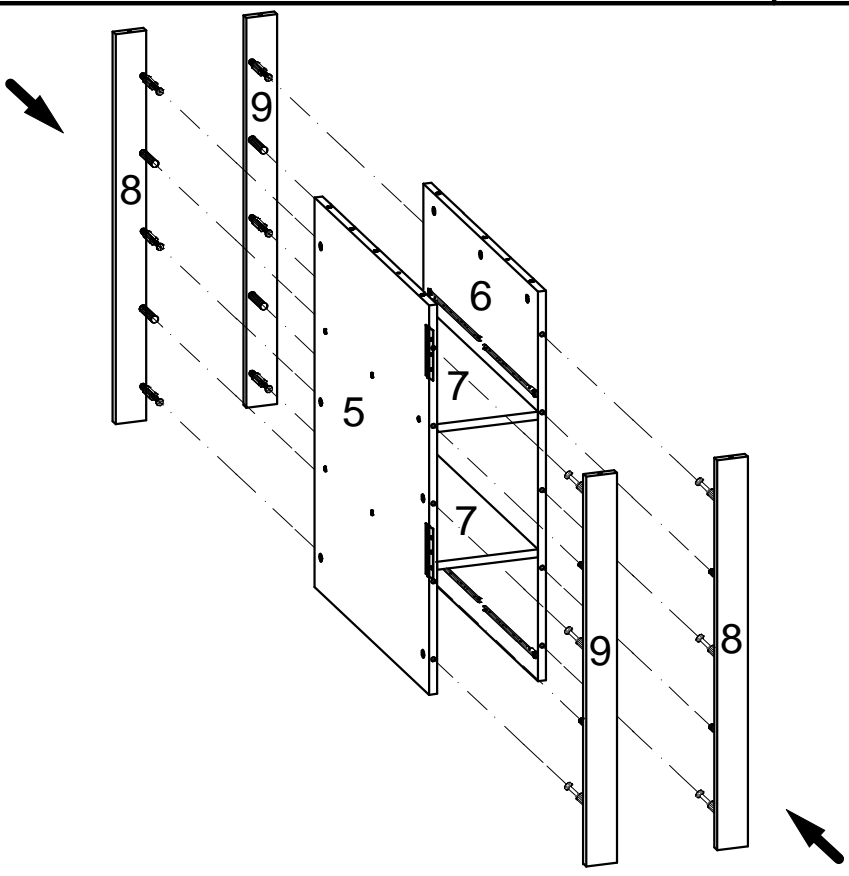
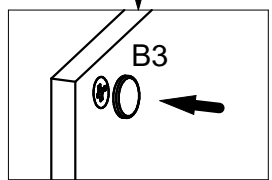
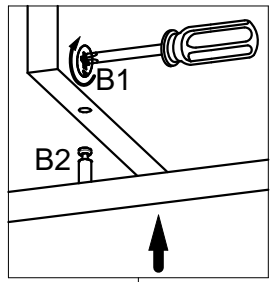
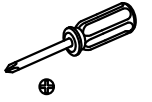
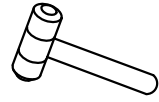

13



D1 x6

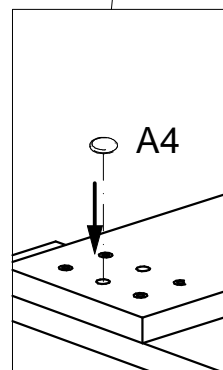
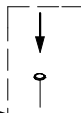
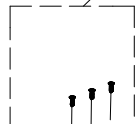
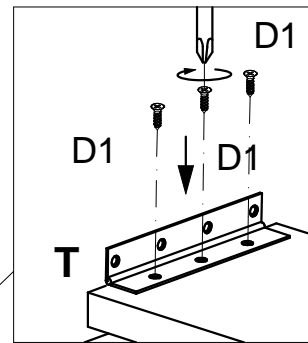
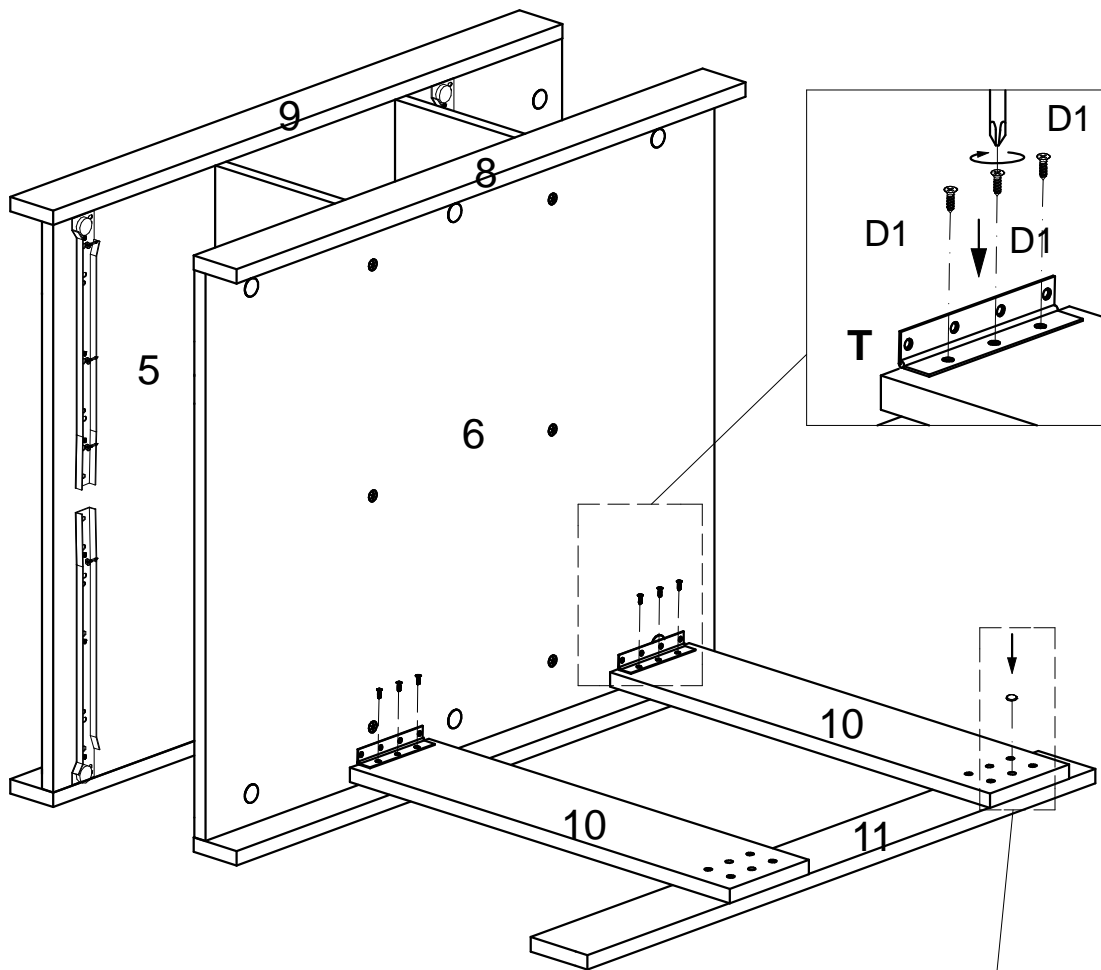
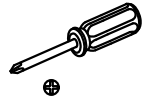

14



D1 x6



A4 x 12

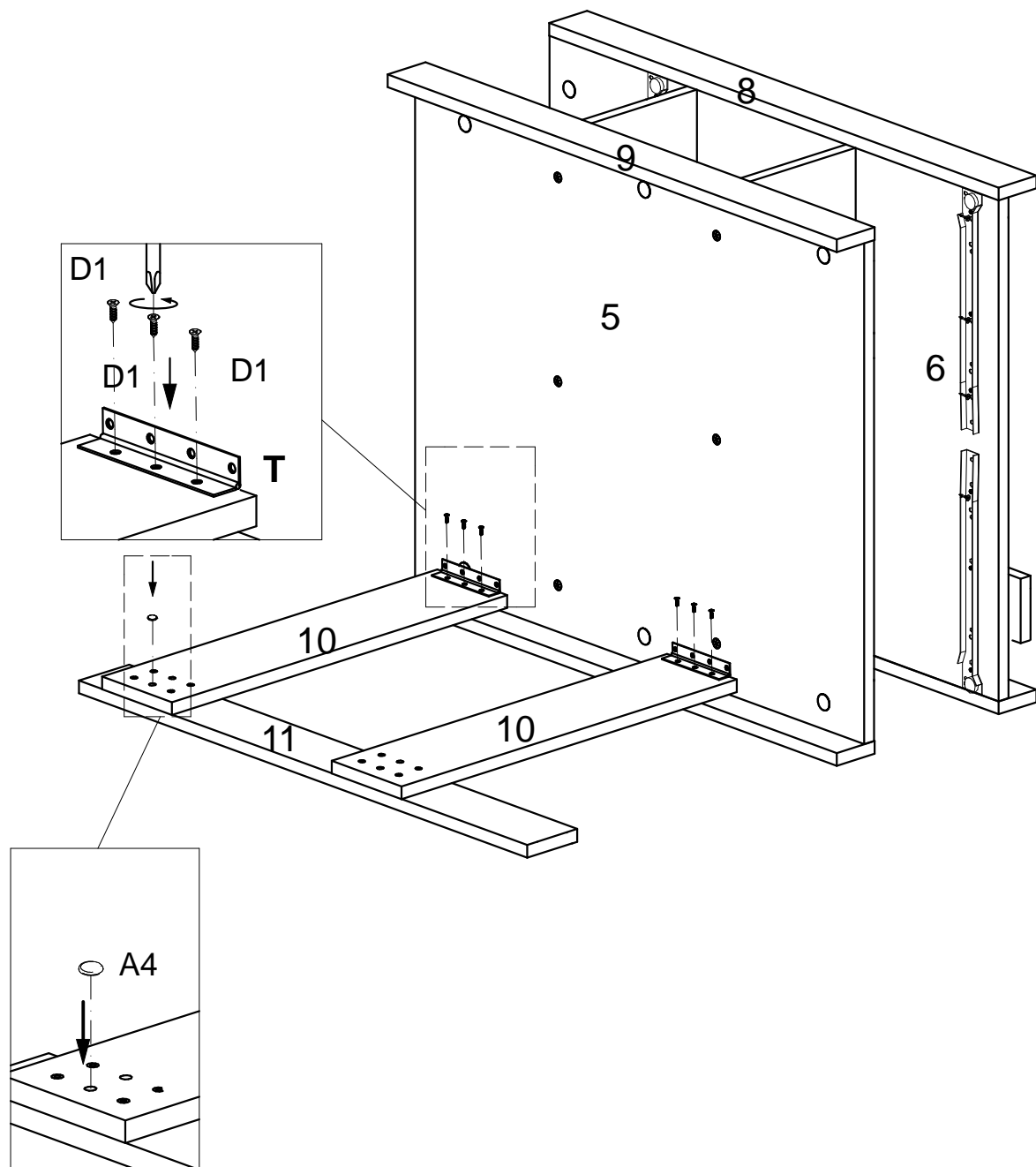
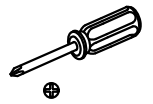

15



D1 x 12



N x 6

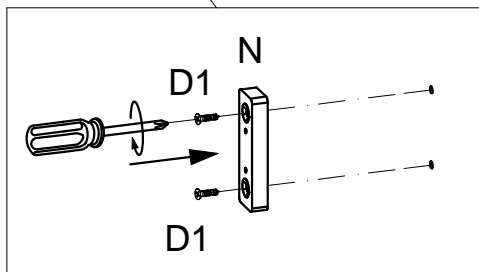
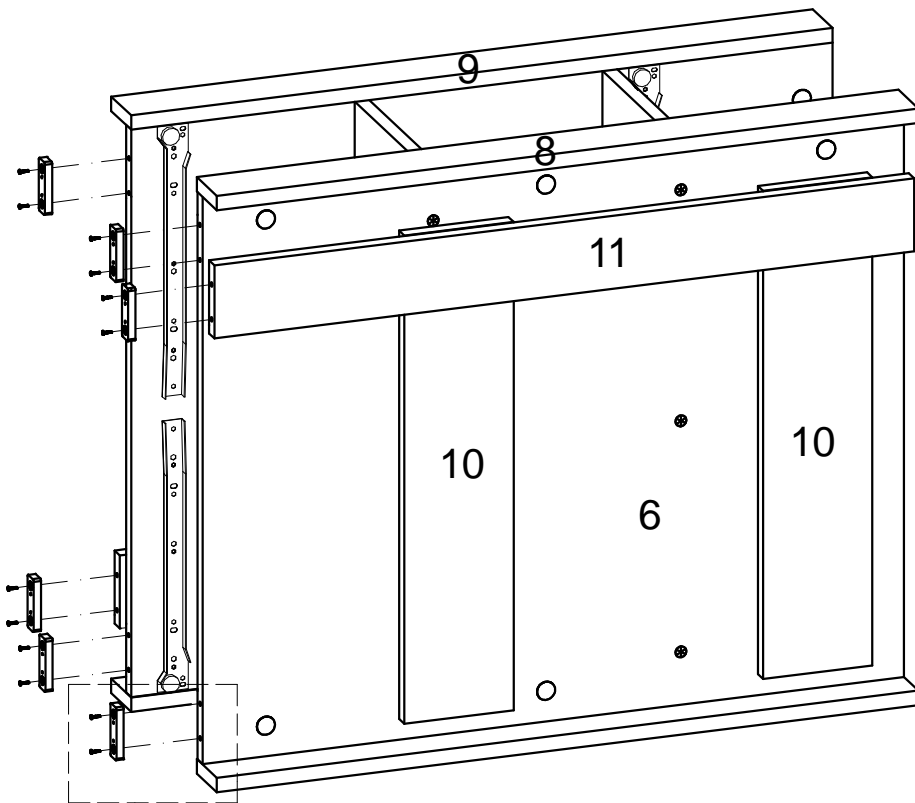
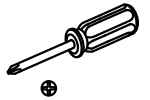

16



B3 x 6

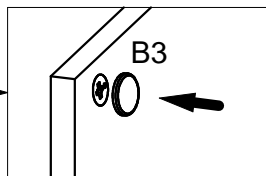
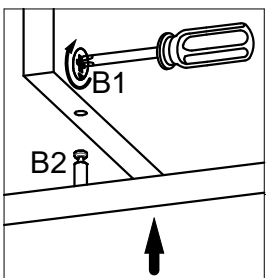
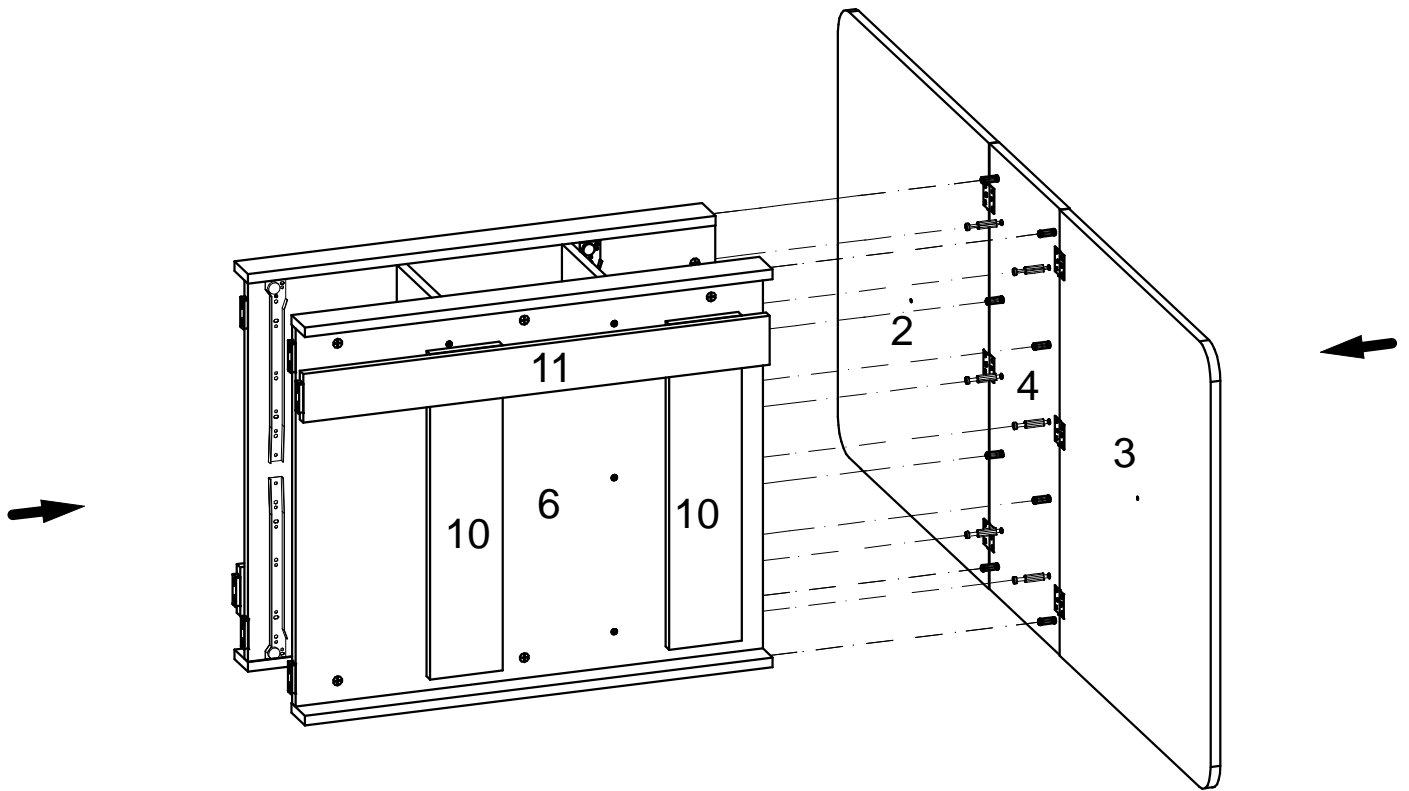
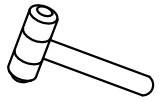

17

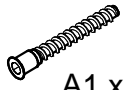

A1 x 8



A2 x 8



A3 x 1



B1 x 4

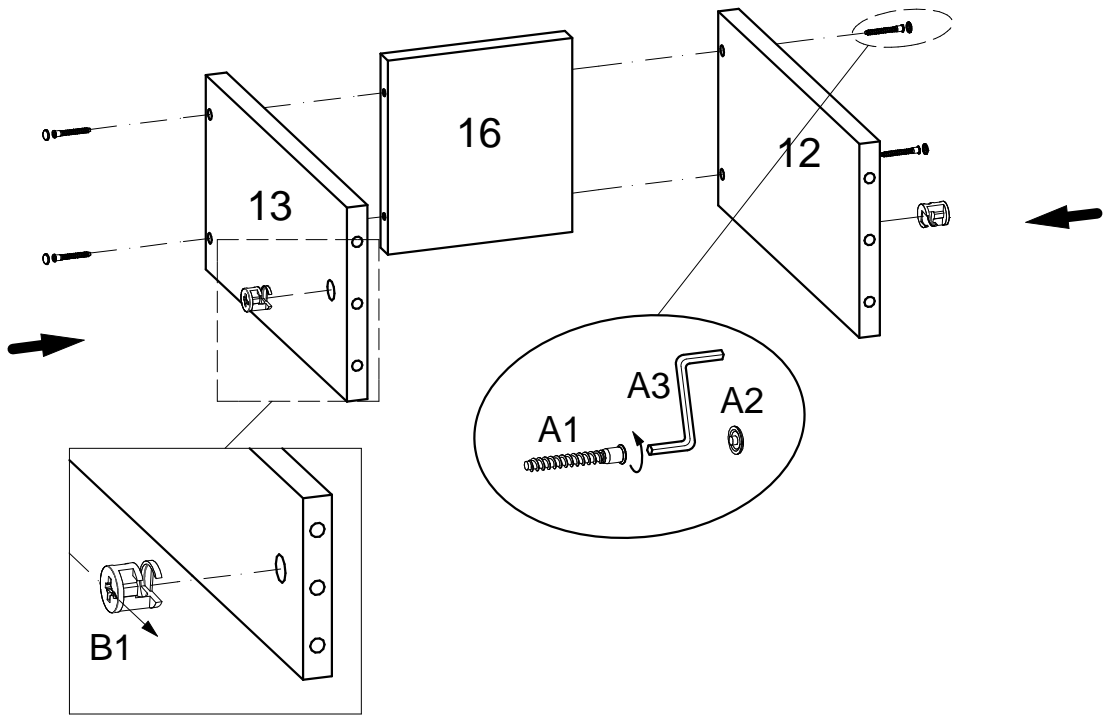

18

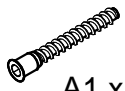

A1 x 8



A2 x 8



A3 x 1



B1 x 4

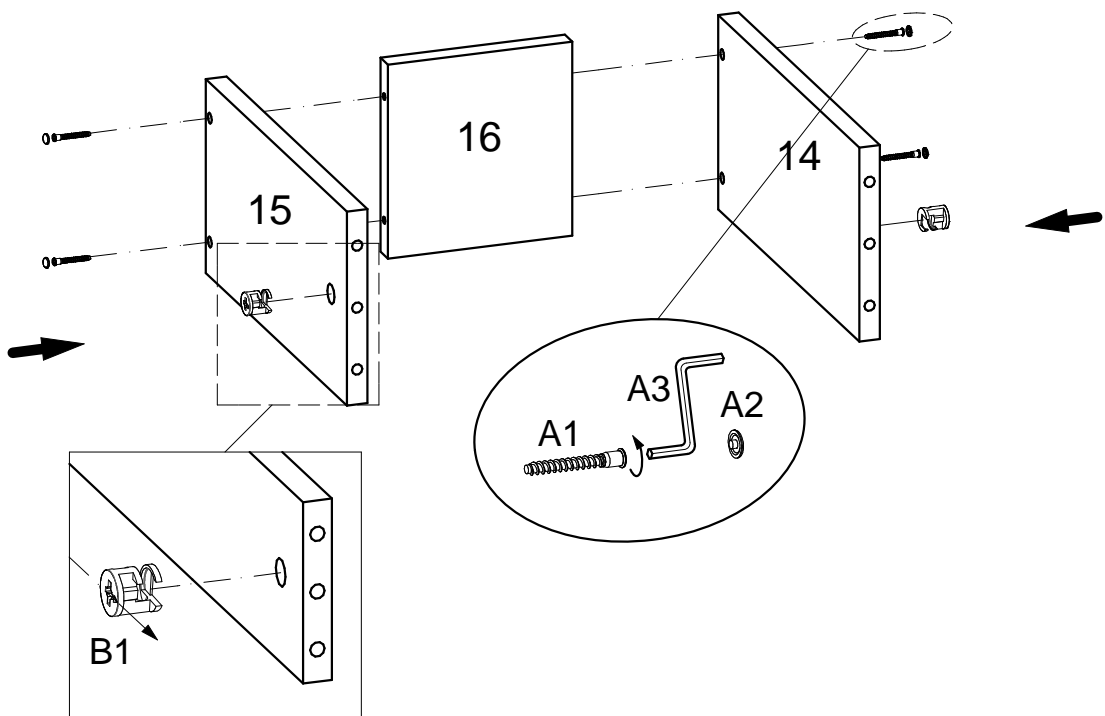

19

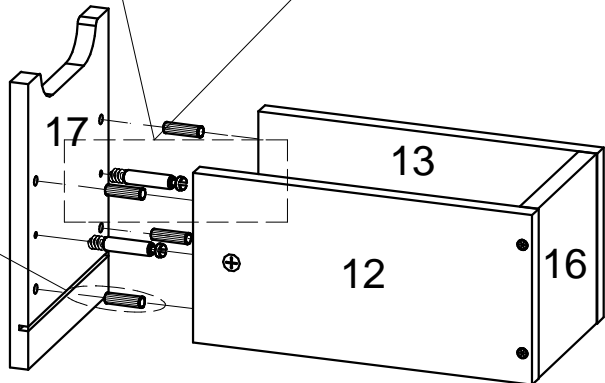
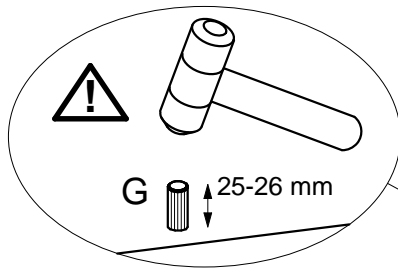
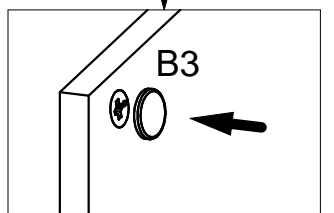
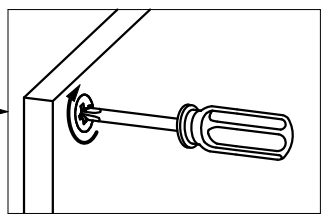
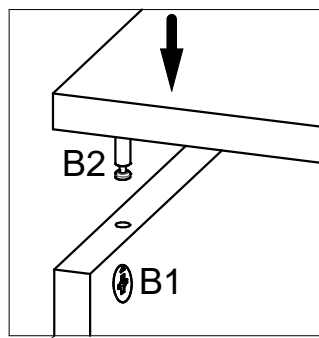
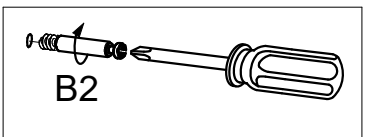
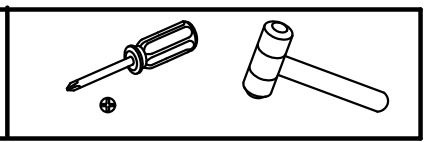
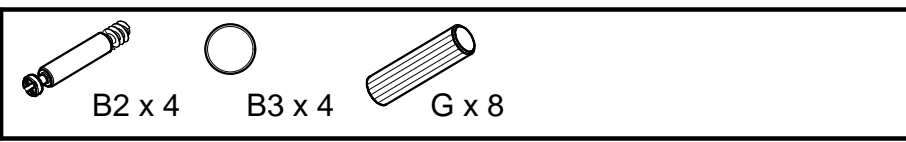

x 2

20

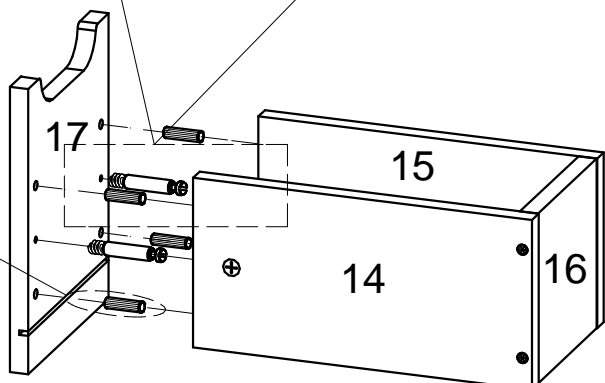
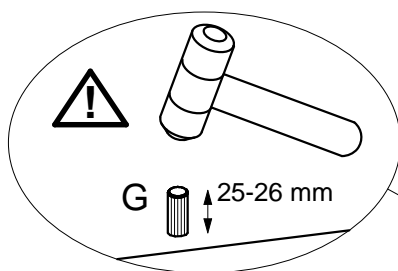
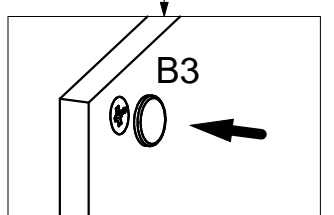
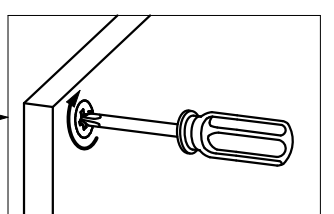
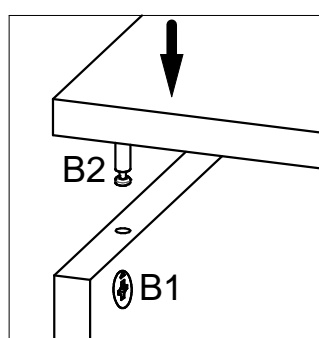
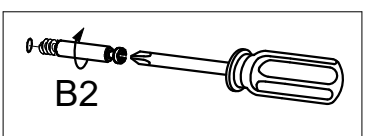
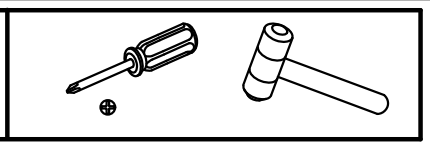
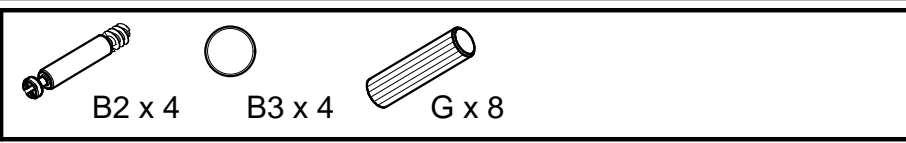

x 2

21

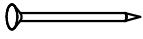

F x 26

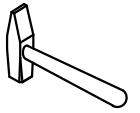

⚠ XX=YY≅90°

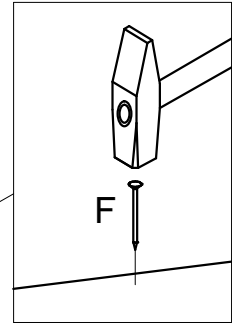
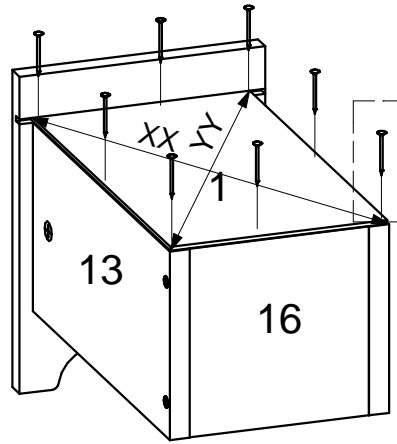

x 2

22

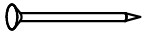

F x 26

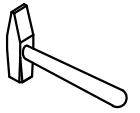

⚠ XX=YY≅90°

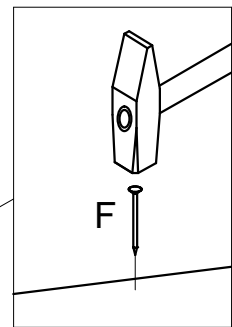
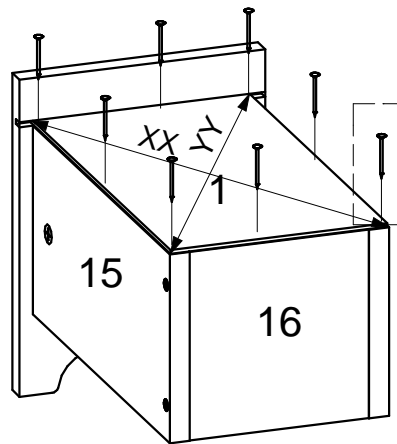

x 2

23



D1 x 12

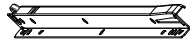

K3 x 2

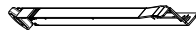

K4 x 2

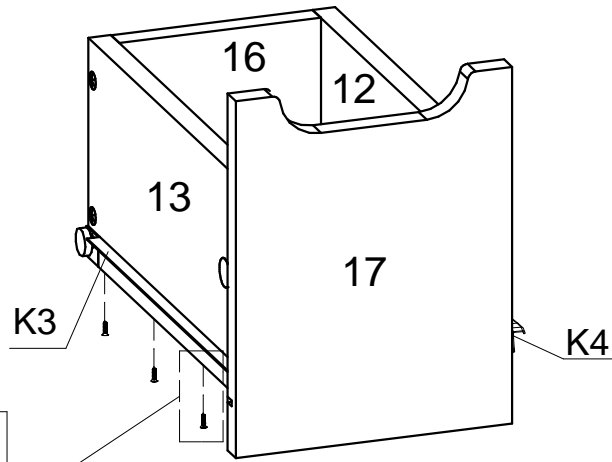
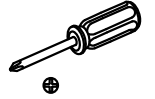

x 2

24



D1 x 12

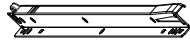

K3 x 2

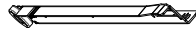

K4 x 2

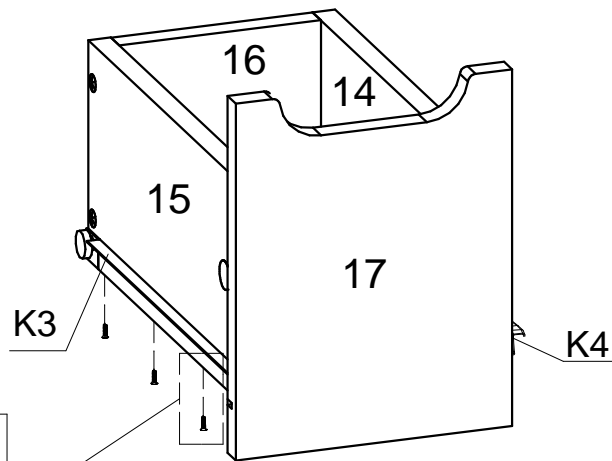
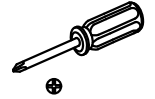

x 2

25

